

Next

Vmix 6

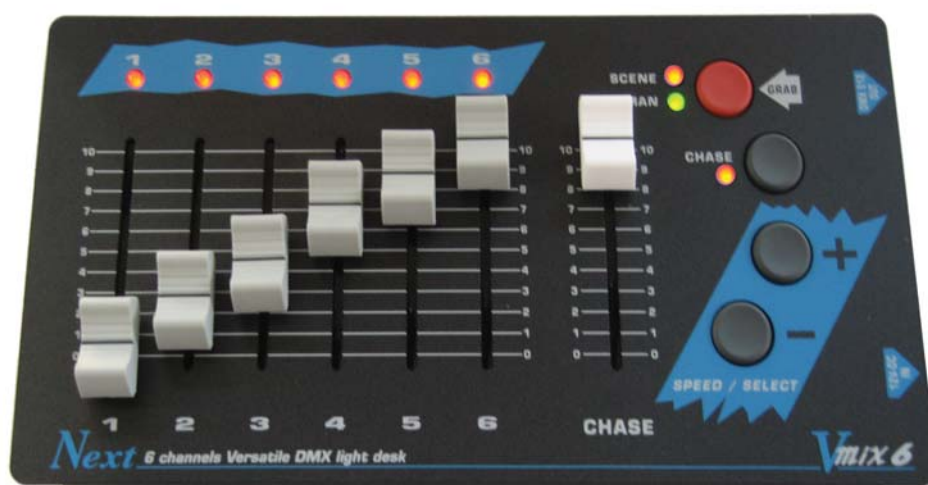

6 channels Versatile DMX light desk



GB **USER'S MANUAL**



*We congratulate you on your purchase of V-MIX 6.
Before you proceed using this product it should be necessary to read
carefully the following user's manual to install it correctly and to get the
best of its potentialities.*

GB FRONT PANEL

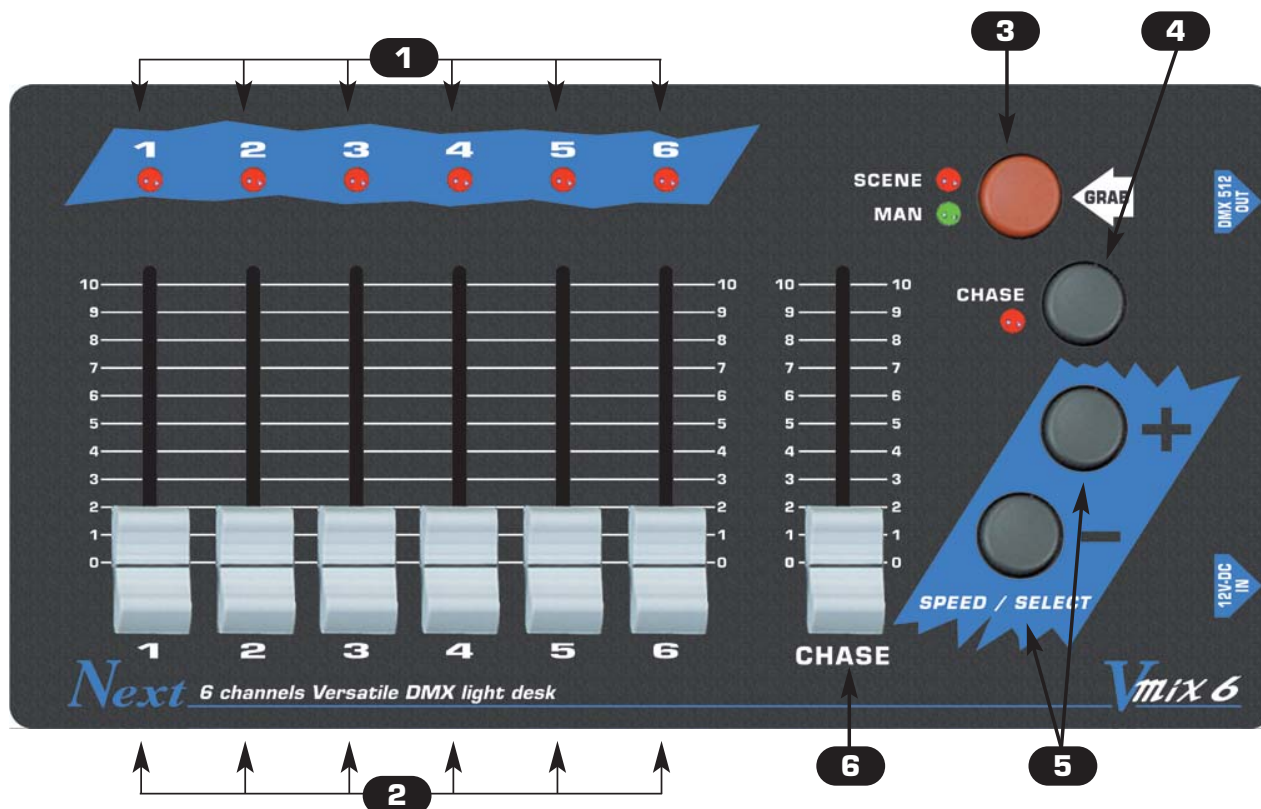

1 Outputs monitor

2 6 faders for manual function (**MAN** mode) or register of memory (**SCENE** mode)

3 Active the mode of operation **MAN/SCENE** and **GRAB**.

4 Active the function for the selection of the **CHASE**

5 They activate the **SPEED** function for speed, or **SELECT** for the selection of the chase.

6 **MASTER CHASE** Fader.

Sets of the equipment

1.1 Unpacking of the equipment

1.2 Accessories issued with the equipment and relative documentation

Description of the side panel and installation

2.1 Description of the side panel

2.2 DMX 512 output connection

2.3 Input connection for power supply

2.4 Connection of the ballast to the electric system

Use of the equipment - modes of operation

3.1 **MAN** Operation

3.2 **GRAB** Function

3.3 **REGISTER OF MEMORY (SCENE)** mode

4.1 **CHASE** Section

4.2 **CHASE** Function

5.1 **Example of working**

1.1 Unpacking of the equipment

GB

Open the box; take the ballast and the documentation out.

Take the equipment out of the box as shown in the picture below.

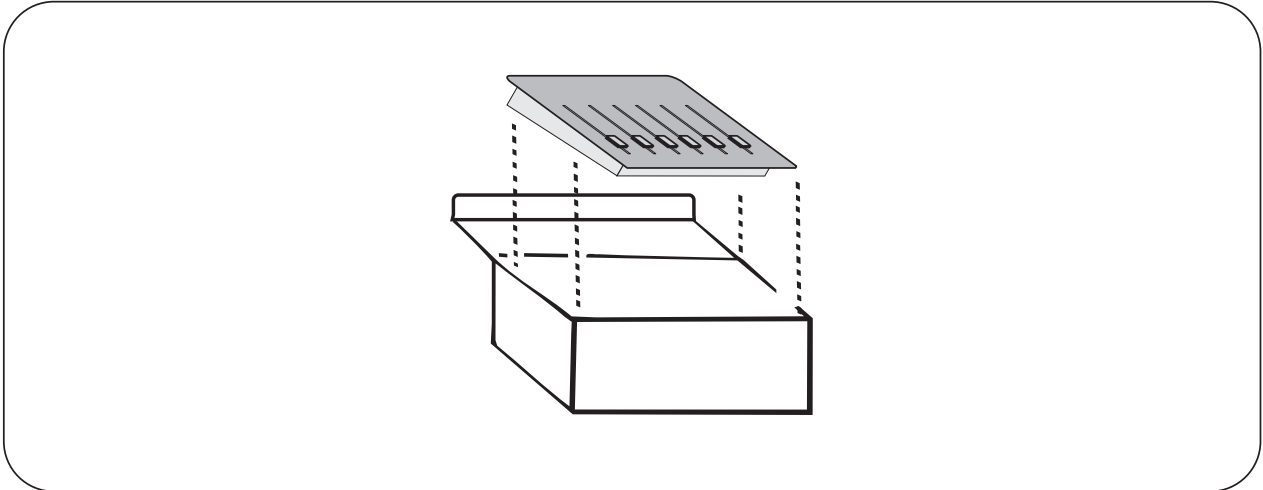

1.2 Accessories issued with the equipment and relative documentation

Verify the contents of the packing.

If one of the following parts of the packing is missing or damaged, please, contact your dealer immediately.

A) User's manual

B) VM6 Ballast

A



B



2.1 DESCRIPTION OF THE SIDE PANEL

GB

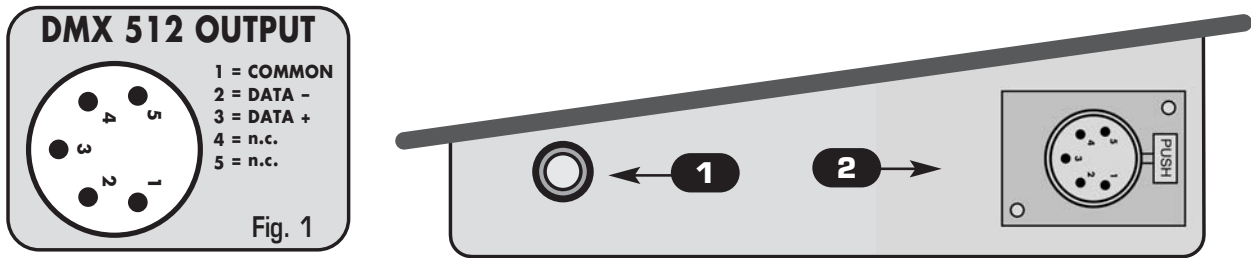

2.2 INPUT CONNECTION FOR POWER SUPPLY

Plug the connector of the ballast completely in the power input **1**
To disconnect it, extract gently.

ATTENTION: do not use ballast different from the one supplied, it could cause serious damages at the internal circuitation.

2.3 DMX 512 OUTPUT CONNECTION

Make sure you are using a shielded twisted cables suitable for the transmission of the DMX 512 signal with connectors of good quality and connection as shown on the side of the connector.

Plug the 5-pin cannon connector coming from the dimmer completely in the DMX 512 output **2**

Use the “push” safety hook to disconnect it and than extract it gently.

ATTENTION: the shielded part of the cable must never be connected to the ground of the electrical system as this could cause faults during the working of the controller.

2.3 CONNECTION OF THE BALLAST TO THE ELECTRIC SYSTEM

MAKE SURE THAT VOLTAGE AND POWER FREQUENCY CORRESPOND TO WHAT IS REPORTED ON THE BALLAST PLATE.

The supplied ballast has a plug, therefore you should only plug it in the socket.

Just inserted the plug in the socket and the connector to the power input, the led on the **MAN** key is turn on. If this condition is not true, please check if there is tension in the electric socket or check the connection between ballast-controller and ballast-electric socket.

If the problem persist, please consult your dealer.

3.1 MAN operation

This function allows to modify manually each output single channel

The **MANUAL** function (**MAN**) is activated pressing the **MAN** key. (Fig. 1)

The activation of the function has signalled from the green light to side of the same key.

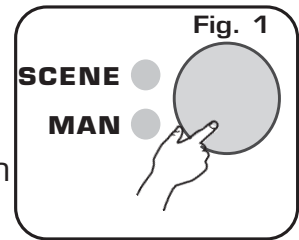

3.2 GRAB Function

The **GRAB** function allows to memorize the state of the channels of output (**SCENE**) in one of the 6 registers of memory.

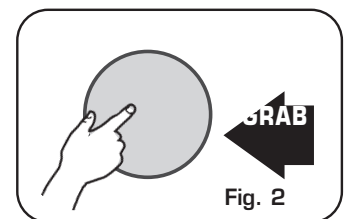

.....
Memorization of the state of the channels of output (**SCENE**) in a register of memory
.....

- Create in output the scene that you want to memorize (in any operational formality).
- Now in the outputs monitor and in output you will have a preview of the **SCENE**.
- Press for over 1 second the **GRAB** key (Fig.2). (the **MAN** + **SCENE** lights must flash)
- On the outputs monitor comes automatically selected the register of active memory.
- Select, if different from the active one, the register of memory on which memorize the **SCENE**., through the key **+** and **-**
- Press the **GRAB** key (Fig.2) for confirm and conclude the copy, otherwise another key for get out of the copy, with no modification.

3.3 REGISTER OF MEMORY (SCENE) mode

The **SCENE** function is activated pressing the **SCENE** key. (Fig.3)

The activation of the function has signalled from the red light to side of the same key.

The 6 faders become **REGISTERS OF MEMORY**, now each of them doesn't control more a single channel, but a memory.

Each memory contains a **SCENE**.

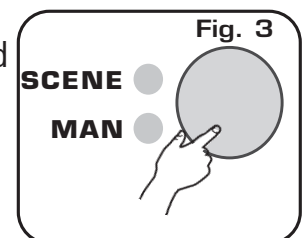

4.1 CHASE SECTION

GB

A CHASE is a play of lights, he is made of a sequence of steps.

The CHASE fader (Fig.4) checks the level of output of the CHASE currently active; keep the CHASE fader to the maximum (100%) for activate it, carry it to 0 for exclude the function.

Through the + and - key (Fig. 5) you can regulate the speed of the currently active CHASE (the time of passage between the steps of the same chase).

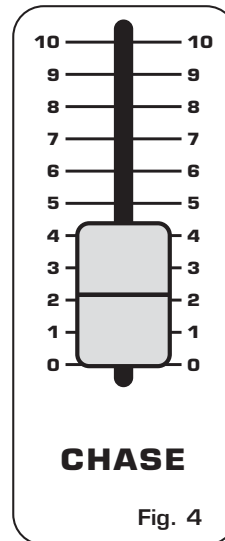

Fig. 4

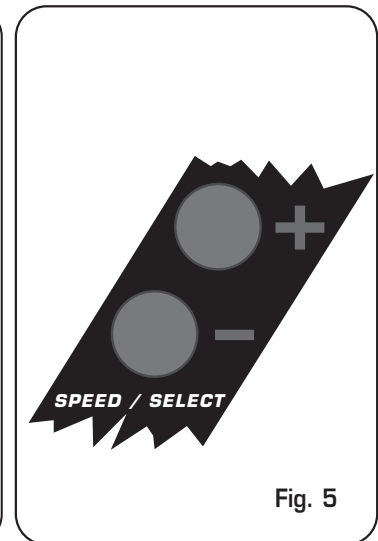

Fig. 5

4.2 CHASE function

The CHASE function allows to select the CHASE active.

The CHASE fader (Fig.4) checks the level of output of the CHASE currently active; keep the CHASE fader to the maximum

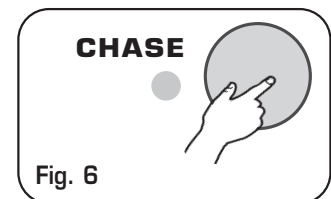

Fig. 6

Pressing the CHASE key, on the outputs monitor you see the CHASE currently active; for select a different one, between the six available, press + e - keys.
press again the CHASE key for get out of the function.

5.1 Example of working



The V-MIX 6 thanks to his evolved software simplify notably all the functions of use and programming.

EXAMPLE OF CREATION OF A SCENE AND TRANSFER TO A REGISTER OF MEMORY.

- Keep the **CHASE** fader to zero.
- Activate the **MAN** operation and create in output the **SCENE** desired through the faders.
- Now in output you have the preview of the **SCENE** to transfer.
- Press for over 1 second the **GRAB** key.
- (the **MAN** and **SCENE** lights to side of the same keys flashes).
- The **OUTPUT MONITOR** show the number of the register in use.
- Select through the **SPEED/SELECT** keys the register of destination of the **SCENE** (is not necessary select it if is the same of that currently in use).
- Press **GRAB** key for memorize the **SCENE** in the selected register.
- Now the selected register contains the **SCENE**
- for use the registers go to **SCENE** operation

USE OF THE GRAB FUNCTION

The GRAB function is of fundamental importance for the programming of the V-MIX 6; but his use has made extremely simple.

It is main point remember that the GRAB function captures all the levels of output and it transfers them in a register of memory; it allows to memorize the exact present scene in output.

It's indifferent in the way in which you have created that scene. What comes memorized is exactly what you see on the outputs monitor and on the stage.

THE LEVELS OF OUTPUT GIVEN BIRTH TO THE CHASE DOESN'T COME MEMORIZED, THEREFORE IT IS ADVISABLE KEEP TO ZERO THE CHASE FADER DURING THE GRAB FUNCTION.

Technical features: programming

Number of channels controlled separately: **6**
Number of register : **6**
Total memory's scene: **6**
Number of CHASE in MEMORY: **6 (not modifiable)**

Technical features: output signal

Kind of output signal: **DMX512/ 1990**
Output connector: **5-pin cannon connector**
Max number of dimmer connected to the DMX output: **32**
Number of DMX channels: **6**

Technical features: storage of settings

Kind of storage / size: **EEPROM / 64 Kbit**
Length of data maintenance without power supply: **> 40 years**
Number of entries cycles: **>10.000.000**

Climatic condition for the use

Humidity: **35% ÷ 80%**
Temperature: **5 ÷ 50 °C**

Power supply

Voltage/current: **12 Vdc / 240 mA**

Dimensions and weight

Dimension (W x L x H) / Weight: **257 x 132 x 40 mm / 2 Kg.**

CODEM MUSIC S.r.l. - Via G.Pierini, 13 - 61100 PESARO - ITALY
Tel. +39 0721 204357 - Fax +39 0721 203554
www.codemmusic.com - www.wi-dmx.com - info@codemmusic.com



All rights reserved. No parts of this document can be copied, photocopied or reproduced without the prior written permission of the **CODEM MUSIC s.r.l.**

No responsibility is taken for possible inaccuracies or mistakes.

The **CODEM MUSIC s.r.l.** reserves the right to make any alterations or aesthetics changes of this product that seem necessary at any time and for whatever reason.

The **CODEM MUSIC s.r.l.** takes no responsibility for the use or for the application of this product.
